



PRODUCT DESCRIPTION

DLC Premium
High efficacy fixture
Easy replacement & installation
Optimal uniformity

APPLICATIONS

Office / Retail / Classrooms / Health & Elderly Care

SPECIFICATIONS

Model Name	BT12-024	
Power Consumption*	24 W	
Correlated Color Temperature*	4,000 K (5000K available)	Tunable (2,700 ~ 6,500 K)
Light Output*	2,700 lm	2,500 lm
Efficacy*	113 lm/W	105 lm/W
Color Rendering Index	87 CRI	
Beam Angle	115°	
LED Chip Manufacturer	SAMSUNG	
Fixture Manufacturer	Samjin / Made in Korea	
Input Voltage	120~277 Vac	
Total Harmonic Distortion	Max 20%	
Power Factor	≥ 0.9 at Max Load	
Input Frequency	50 / 60 Hz	
Size (L x W x H)	23.7 x 23.7 x 3.3 (in)	
Weight (Including Driver)	9.9 lb	
IP Rating	IP20	
Mounting Option	Recessed Troffer (2x2)	
Operating Temperature	14°F ~ 122°F (-10°C ~ 50°C)	
Limited Warranty	5-Year Warranty (Terms and Conditions Apply)	

CERTIFICATIONS



DIMENSIONS

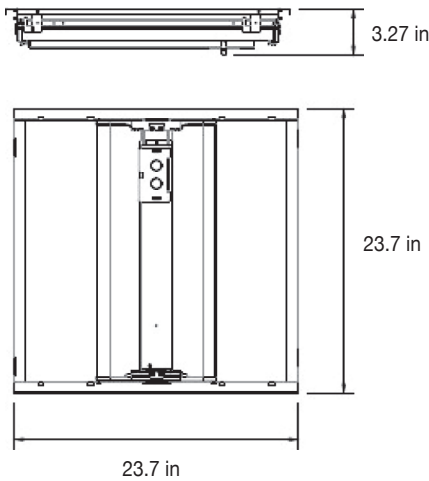

Options

Control Options	CCT Tunable & Dimming, Dimming, 0-10V Dimming
-----------------	---

Accessories (Ordered Separately)

Wall Controller	Required per area for SK and SD models
Sensors	Occupancy

*Tolerance: ± 5%

ORDERING INFORMATION

Order Code Example : **BT12-024SKCT-USR2**

BT12	-	024	XX	XX	-	USR2
PRODUCT FAMILY		POWER	CONTROL	CCT		FIXTURE SIZE
Beetle		24W	SK = CCT Tunable & Dimming DM = 0-10V Dimming	CT = 2700~6500K 40 = 4000K 50 = 5000K		2x2