



PRODUCT DESCRIPTION

DLC Premium
 High Efficacy Fixture (125 lm/W)
 Easy Replacement & Installation
 Optimal Uniformity

APPLICATIONS

Office / Retail / Classrooms / Health & Elderly Care

SPECIFICATIONS

Model Name	BT22-030
Power Consumption*	29.1 W
Correlated Color Temperature*	5,000 K
Light Output*	3,645 lm
Efficacy*	125 lm/W
Color Rendering Index	87 CRI
Beam Angle	115°
LED Chip Manufacturer	SAMSUNG
Fixture Manufacturer	Samjin / Made in Korea
Input Voltage	120~277 Vac
Total Harmonic Distortion	~ 10%
Power Factor	≥ 0.9 at Max Load
Input Frequency	50 / 60 Hz
Size (L x W x H)	23.7 x 23.7 x 3.27 (in)
Weight (Including Driver)	9.9 lb
IP Rating	IP20
Mounting Option	Recessed Troffer (2x2)
Operating Temperature	14°F ~ 122°F (-10°C ~ 50°C)
Limited Warranty	7 Years (Refer to website for details)

Options

Control Options	0-10V Dimming (On/Off Operation Compatible)
-----------------	---

*Tolerance: ± 5%

CERTIFICATIONS



DIMENSIONS

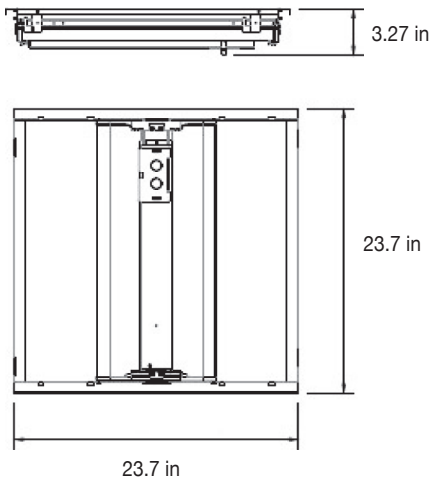

ORDERING INFORMATION

Order Code Example : **BT22-030ZT50SUS**

BT22	-	030	ZT	50	S	US
PRODUCT FAMILY		POWER	CONTROL	CCT	LED CHIP	REGION
Beetle 2x2		30W	0-10V Dimming	5000K	Higher Efficacy	US/CAN