



PRODUCT DESCRIPTION

DLC Premium
High efficacy fixture
Easy replacement & installation
Optimal uniformity

APPLICATIONS

Office / Retail / Classrooms / Health & Elderly Care

SPECIFICATIONS

Model Name	BT12-032		
Power Consumption*	24 W	33 W	24 W
Correlated Color Temperature*	4,000 K	5,000 K	Tunable (2,700 ~ 6,500 K)
Light Output*	2,843 lm	3,114 lm	2,500 lm
Efficacy*	113 lm/W	95 lm/W	105 lm/W
Color Rendering Index	88 CRI		
Beam Angle	115°		
LED Chip Manufacturer	SAMSUNG		
Fixture Manufacturer	Samjin / Made in Korea		
Input Voltage	120~277 Vac		
Total Harmonic Distortion	Max 20%		
Power Factor	≥ 0.9 at Max Load		
Input Frequency	50 / 60 Hz		
Size (L x W x H)	23.7 x 23.7 x 3.3 (in)		
Weight (Including Driver)	9.9 lb		
IP Rating	IP20		
Mounting Option	Recessed Troffer (2x2)		
Operating Temperature	14°F ~ 122°F (-10°C ~ 50°C)		
Limited Warranty	7-Year Warranty (Terms and Conditions Apply)		

CERTIFICATIONS



DIMENSIONS

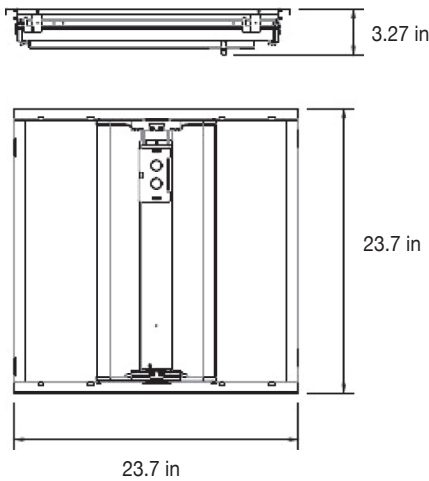

Options

Control Options	CCT Tunable & Dimming, Dimming, 0-10V Dimming
-----------------	---

Accessories (Ordered Separately)

Wall Controller	Required per area for SK and SD models
Sensors	Occupancy

*Tolerance: ± 5%

ORDERING INFORMATION

Order Code Example : **BT12-032SKCT-USR2**

BT12	-	032	XX	XX	-	USR2
PRODUCT FAMILY		POWER	CONTROL	CCT		FIXTURE SIZE
Beetle		32W	SK = CCT Tunable & Dimming SD = Dimming (used with Samjin Wall Cont.) DM = 0-10V Dimming	CT = 2700~6500K 40 = 4000K 50 = 5000K		2x2